

- (15) if the temperature alarm does not disappear at the end of the time you have set with the parameter A3, it will further be excluded for the time you have set with the parameter A6; if the temperature alarm takes place during the defrost and does not disappear at the end of the time you have set with the parameter A7, it will further be excluded for the time you have set with the parameter A6
- (16) the evaporator fan stop temperature is "cabinet temperature - F1"; you always have to consider the parameter F1 with positive sign.

FK 209A

ON-OFF digital controller for ventilated refrigerating units (with compressor protection)

Version 1.00 of April 28th, 2003

File fk209ae_v1.00.pdf

PT

EVERY CONTROL S.r.l.

This Company belongs to **EVCO group**

Via Mezzaterra 6, 32036 Sedico Belluno ITALY

Phone 0039-0437-852468 • Fax 0039-0437-83648

info@everycontrol.it • www.everycontrol.it

ENGLISH

1 PREPARATIONS

1.1 How to install the instrument

Panel mounting, panel cut out 71 x 29 mm (2.79 x 1.14 in), with click brackets (they are supplied by the builder) or screw brackets (by request).

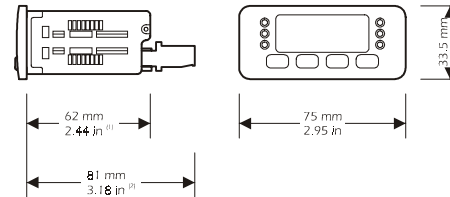

(1) maximum depth with screw terminal blocks (by request)

(2) maximum depth with extractable terminal blocks (standard model).

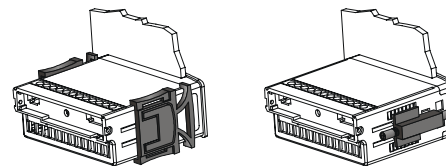

Every Control S.r.l. • FK 209A • Sheet 1/2

Installation with click brackets (on the left-hand side, they are supplied by the builder)

and screw brackets (on the right-hand side, by request); if you are using screw brackets, you have to moderate the clamping torque, in order not to damage the box and screw brackets.

1.2 Electrical connection

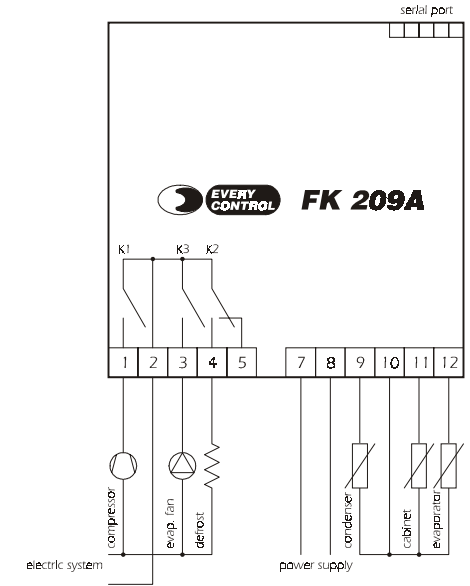

2 OPERATION

2.1 Preliminary information

During the normal operation the instrument shows the cabinet temperature ⁽³⁾.

⁽³⁾ if the parameter /C has value 2, during the normal operation the instrument will show the condenser temperature.

2.2 How to silence the buzzer

If you have to silence the buzzer:

- press

2.3 How to activate the defrost by hand

If you have to activate the defrost by hand:

- press for 4 s

Unless the evaporator temperature is below the defrost end temperature you have set with the parameter d2, the defrost will not be activated.

2.4 How to show the condenser temperature

If you have to show the condenser temperature:

- press   ⁽⁴⁾

(4) if the parameter /C has value 2, if you press  the instrument will show the cabinet temperature.

3 WORKING SETPOINT

3.1 How to set the working setpoint

If you have to modify the working setpoint value:

- press  and  ⁽⁵⁾

(5) you can set the working setpoint between the limits you have set with the parameters r1 and r2.

4 CONFIGURATION PARAMETERS

4.1 How to set the configuration parameters

Configuration parameters are arranged on two levels.

If you have to gain access the first level:

- press  and  for 4 s : the instrument will show *PR*

If you have to select a parameter:

- press  or 

If you have to modify the value of the parameter:

- press  and  or 

If you have to gain access the second level:

- gain access the first level

- press  or  for selecting *PR*

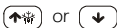
- press  and  or  for setting "**-19**"

- press  and  for 4 s : the instrument will show *PD*



If you have to quit the procedure:

- press  and  for 4 s  or do not operate for about 60 s.

5 SIGNALS

5.1 Signals

	Compressor LED
	if it is lighted, the compressor will be ON
	if it flashes, a compressor delay will be running (look at the parameters C0, C1, C2 and C4)

	Defrost LED
	if it is lighted, the defrost output will be activated
	if it flashes:
	<ul style="list-style-type: none"> a defrost delay will be running (look at the parameters C0, C1, C2 and C4) the dripping will be running (look at the parameter d7) the freezing fluid heating will be running (look at the parameter dP)
	Evaporator fan LED
	if it is lighted, the evaporator fan will be ON
	if it flashes, the after dripping evaporator fan delay will be running (look at the parameter F5)

6 ALARMS

6.1 Alarms

CODE	REASONS	REMEDIES	EFFECTS
<i>E2</i>	there is the corruption of the configuration data of the memory of the instrument	switch off the power supply of the instrument: unless the alarm disappears, you will have to change the instrument	<ul style="list-style-type: none"> you can not gain access the setting procedures all outputs will be forced OFF
<i>ED</i>	<ul style="list-style-type: none"> the kind of cabinet probe you have connected is not right the cabinet probe plays up the connection instrument-cabinet probe is wrong the cabinet temperature is outside the limits allowed by the working range of the instrument 	<ul style="list-style-type: none"> look at the parameter /0 test the integrity of the probe test the instrument-probe connection test the temperature close to the probe (it has to be between the limits allowed by the working range) 	<ul style="list-style-type: none"> the compressor will work in accordance with the parameters C5 and C6 if the defrost is running, it will immediately end the defrost will never be activated

A7	0	240	min	15	temperature alarm exclusion time since the end of the after dripping evaporator fan delay (since the end of F5, it is important if A1 and/or A2 ≠ 0)
----	---	-----	-----	----	--

LABEL	MIN.	MAX.	U.M.	DEF.	EVAPORATOR FAN
F1	-55	99	°C/°F ⁽⁶⁾	-1	evaporator fan stop temperature (evaporator temperature, it is important if /A = 1 and F7 = 3 or 4); look at F6 as well
F2	1	15	°C/°F ⁽⁶⁾	2	hysteresis (differential, it is relative to F1, it is important if /A = 1 and F7 = 3 or 4)
F4	0	2	—	0	evaporator fan action during the defrost and dripping (0 = it will be forced OFF, 1 = it will be forced ON, 2 = it will work in accordance with F7)
F5	0	15	min	2	after dripping evaporator fan delay
F6	0	1	—	0	kind of evaporator fan stop temperature (it is important if /A = 1 and F7 = 3 or 4; 0 = absolute evaporator fan stop temperature, 1 = evaporator fan stop temperature relative to the cabinet temperature) ⁽¹⁶⁾
F7	0	4	—	4	evaporator fan action during the normal operation (0 = it will be forced OFF, 1 = it will be forced ON, 2 = it will work in accordance with the compressor, 3 = it will work in accordance with F1 and F2, 4 = if the compressor is ON, it will work in accordance with F1 and F2, if the compressor is OFF, it will be forced OFF)

LABEL	MIN.	MAX.	U.M.	DEF.	SERIAL NETWORK (EVCOBUS)
L1	1	15	—	1	instrument address
L2	0	7	—	0	instrument group
L4	0	3	—	1	baud rate (0 = 1,200 baud, 1 = 2,400 baud, 2 = 4,800 baud, 3 = 9,600 baud)

(6) the unit of measure depends on the parameter /8

(7) once you have modified the value of the parameter, you will have to switch off the power supply of the instrument

(8) if the parameter has value 0, the defrost will end by time (parameter d3); if the parameter F7 has value 3 or 4, the evaporator fan will work in accordance with the compressor, except what you have set with the parameters F4 and F5

(9) if the time the compressor is ON is lower than 30 s, the compressor will never be ON; if the cabinet probe failure takes place during a compressor delay, the compressor will be forced OFF for 1 min; the parameter C1 sets the minimum delay between the end of the cabinet probe failure and the following activation of the compressor (if the parameter C1 has value 0, the compressor will be forced off for 2 min)

(10) the hysteresis value is 2 °C

(11) if at the moment you turn the instrument ON the condenser temperature is above the threshold you have set with the parameter C8, the parameter C9 will not be considered

(12) unless the evaporator temperature is below the defrost end temperature you have set with the parameter d2, the defrost will not be activated

(13) if at the moment of the defrost activation the cabinet temperature is below the value "working setpoint + r0", the instrument will not show temperatures above that value; if at the moment of the defrost activation the cabinet temperature is above the value "working setpoint + r0", the instrument will not show the increases of the temperature (if the increase takes place below the value "working setpoint + r0", look at the previous case); the instrument restores the normal operation once the after dripping evaporator fan delay ends and the cabinet temperature falls below the freeze temperature

(14) if at the moment of the defrost activation the compressor is ON since a time lower than the one you have set with the parameter, the compressor will be forced ON for a time such as to finish the time you have set with the parameter

LABEL	MIN.	MAX.	U.M.	DEF.	COMPRESSOR PROTECTION
C0	0	240	min	0	minimum delay between you turn the instrument ON and the first compressor activation
C1	0	240	min	5	minimum delay between two compressor activation in succession
C2	0	240	min	3	minimum delay between the compressor gets OFF and the following activation
C4	0	1	—	0	fixed delay since the compressor gets ON and OFF (1 = YES, for 3 s)
C5	1	240	min	10	cycle time for the compressor activation during the cabinet probe alarm
C6	0	100	%	50	percentage of C5 the compressor is ON during the cabinet probe failure ⁽⁹⁾
C7	0	200	°C/°F ⁽⁶⁾	80	temperature alarm threshold for condenser overheat alarm (condenser temperature, it is important if /C = 1) ⁽¹⁰⁾
C8	0	200	°C/°F ⁽⁶⁾	90	temperature alarm threshold for condenser shut-down alarm (condenser temperature, it is important if /C = 1)
C9	0	15	min	1	condenser shut-down alarm exclusion time (it is important if /C = 1) ⁽¹¹⁾

LABEL	MIN.	MAX.	U.M.	DEF.	DEFROST
d0	0	99	h	8	defrost interval ⁽¹²⁾ (0 = the defrost will never automatically be activated)
d1	0	1	—	0	kind of defrost (0 = electric defrost, 1 = hot gas defrost)
d2	-55	99	°C/°F ⁽⁶⁾	2	defrost end temperature (evaporator temperature, it is important if /A = 1)
d3	0	240	min	30	defrost maximum length (0 = the defrost will never be activated)
d4	0	1	—	0	defrost activation every time you turn the instrument ON (1 = YES) ⁽¹²⁾
d5	0	99	min	0	delay between you turn the instrument ON and the defrost activation (it is important if d4 = 1)
d6	0	1	—	1	freeze of the temperature showed by the instrument during the defrost (1 = YES) ⁽¹³⁾
d7	0	15	min	2	dripping time
d9	0	1	—	0	compressor protections cleaning at the moment of the defrost activation (it is important if d1 = 1; 1 = YES)
dA	—	—	°C/°F ⁽⁶⁾	—	evaporator temperature showing (it is important if /A = 1)
dP	0	99	min	0	minimum time the compressor must have been ON at the moment of the defrost activation in order that the defrost can be activated (it is important if d1 = 1) ⁽¹⁴⁾

LABEL	MIN.	MAX.	U.M.	DEF.	ALARMS
A0	1	15	°C/°F ⁽⁶⁾	2	hysteresis (differential, it is relative to A1 and A2, it is important if A1 and/or A2 ≠ 0)
A1	-55	0	°C/°F ⁽⁶⁾	-10	lower temperature alarm threshold (it is relative to the working setpoint, 0 = it will never be activated)
A2	0	99	°C/°F ⁽⁶⁾	10	upper temperature alarm threshold (it is relative to the working setpoint, 0 = it will never be activated)
A3	0	240	min	120	temperature alarm exclusion time since you turn the instrument ON (it is important if A1 and/or A2 ≠ 0)
A6	0	240	min	5	temperature alarm exclusion time (it is important if A1 and/or A2 ≠ 0) ⁽¹⁵⁾

E1	the kind of evaporator probe alarm	<ul style="list-style-type: none"> the kind of evaporator probe you have connected is not right the evaporator probe plays up the connection instrument-evaporator probe is wrong the evaporator temperature is outside the limits allowed by the working range of the instrument 	<ul style="list-style-type: none"> look at the parameter /0 test the integrity of the probe test the instrument-probe connection test the temperature close to the probe (it has to be between the limits allowed by the working range) 	<ul style="list-style-type: none"> if the parameter F7 has value 3 or 4, the evaporator fan will work in accordance with the compressor, except what you have set with the parameters F4 and F5 the defrost will end by time (parameter d3)
E3	the kind of condenser probe alarm	<ul style="list-style-type: none"> the kind of condenser probe you have connected is not right the condenser probe plays up the connection instrument-condenser probe is wrong the condenser temperature is outside the limits allowed by the working range of the instrument 	<ul style="list-style-type: none"> look at the parameter /0 test the integrity of the probe test the instrument-probe connection test the temperature close to the probe (it has to be between the limits allowed by the working range) 	no effects
COH	the condenser temperature is outside the limit you have set with the parameter C7	<ul style="list-style-type: none"> test the temperature close to the probe (look at the parameter C7) clean the condenser 	no effects	

CSd	the condenser temperature is outside the limit you have set with the parameter C8	<ul style="list-style-type: none"> turn the refrigerator OFF test the temperature close to the probe (look at the parameter C8) clean the condenser switch off the power supply of the instrument 	<ul style="list-style-type: none"> all outputs will be forced OFF if the defrost is running, it will immediately end the defrost will never be activated
cabinet temperature alarm	the cabinet temperature is outside the limit you have set with the parameter A1 or A2	<ul style="list-style-type: none"> test the temperature close to the probe (look at the parameters A0, A1 and A2) 	no effects

The instrument shows the indications above alternated with the cabinet temperature, except the indications 'E2' and 'E0' (they flash).

7 TECHNICAL DATA

7.1 Technical data

Box: self-extinguishing grey.

Size: 75 x 33.5 x 81 mm (2.95 x 1.31 x 3.18 in) the model with extractable terminal blocks (standard model), 75 x 33.5 x 62 mm (2.95 x 1.31 x 2.44 in) the model with screw terminal blocks (by request).

Installation: panel mounting, panel cut out 71 x 29 mm (2.79 x 1.14 in), with click brackets (they are supplied by the builder) or screw brackets (by request).

Frontal protection: IP 65.

Connections: extractable terminal blocks with pitch 5 mm (0.19 in, standard model) for cables up to 2.5 mm² (0.38 sq in, power supply, inputs and outputs) or screw terminal blocks with pitch 5 mm (0.19 in, by request) for cables up to 2.5 mm² (0.38 sq in, power supply, inputs and outputs), 5 poles single line male connector with pitch 2.5 mm (0.09 in, serial port).

Ambient temperature: from 0 to 55 °C (32 to 131 °F; 10 ... 90% of relative humidity without condensate).

Power supply: 12 Vac/dc, 50/60 Hz, 1.5 VA.

Alarm buzzer: included.

Measure inputs: 3 (cabinet, evaporator and condenser probe) for PTC or NTC probes.

Working range: from -50 to 150 °C (-58 to 302 °F) for PTC probe, from -40 to 110 °C

(-40 to 230 °F) for NTC probe.

Setpoint range: from -55 to 99 °C (-55 to 99 °F).

Resolution: 1 °F with unit of measure in Fahrenheit, 1 °C with unit of measure in Celsius.

Display: one red LED 3-digit display 13.2 mm (0.51 in) high, output status indicators.

Outputs: 3 relays: one 10 A @ 250 Vac relay for one ½ HP @ 230 Vac compressor control (NO contact), one 8 A @ 250 Vac relay for evaporator fan control (NO contact) and one 8 A @ 250 Vac relay for defrost system control (change-over contact).

Kind of defrost: electric and hot gas defrost.

Defrost control: defrost interval, defrost end temperature and defrost maximum length (automatic and by hand).

Serial port: TTL with EVCOBUS communication protocol (for the configurator/cloner system CLONE and supervision system RICS).

8 WORKING SETPOINT AND CONFIGURATION PARAMETERS

8.1 Working setpoint

LABEL	MIN.	MAX.	U.M.	DEF.	WORKING SETPOINT
	r1	r2	°C/°F ⁽⁶⁾	0	working setpoint

8.2 First level parameters

LABEL	MIN.	MAX.	U.M.	DEF.	PASSWORD
PA	-55	99	—	0	password

LABEL	MIN.	MAX.	U.M.	DEF.	MEASURE INPUTS
/1	-55	99	°C/°F ⁽⁶⁾	0	cabinet probe calibration (you have to set ten points for adjusting one degree)
/6	-55	99	°C/°F ⁽⁶⁾	0	evaporator probe calibration (it is important if /A = 1, you have to set ten points for adjusting one degree)
/9	-55	99	°C/°F ⁽⁶⁾	0	condenser probe calibration (it is important if /C ≠ 0, you have to set ten points for adjusting one degree)

LABEL	MIN.	MAX.	U.M.	DEF.	REGULATOR
r0	1	15	°C/°F ⁽⁶⁾	2	hysteresis (differential, it is relative to the working setpoint)

LABEL	MIN.	MAX.	U.M.	DEF.	DEFROST
dA	—	—	°C/°F ⁽⁶⁾	—	evaporator temperature showing

8.3 Second level parameters

LABEL	MIN.	MAX.	U.M.	DEF.	MEASURE INPUTS
/0	1	4	—	1	kind of probe (1 = PTC, 2 = reserved, 3 = NTC, 4 = reserved)
/1	-55	99	°C/°F ⁽⁶⁾	0	cabinet probe calibration (you have to set ten points for adjusting one degree)
/6	-55	99	°C/°F ⁽⁶⁾	0	evaporator probe calibration (it is important if /A = 1, you have to set ten points for adjusting one degree)
/8	0	1	—	1	temperature unit of measure (0 = Fahrenheit degree, 1 = Celsius degree)
/9	-55	99	°C/°F ⁽⁶⁾	0	condenser probe calibration (it is important if /C ≠ 0, you have to set ten points for adjusting one degree)
/A	0	1	—	1	evaporator probe presence (and its functions; 1 = YES) ^{(7) (8)}
/C	0	2	—	1	condenser probe operation (0 = probe not enabled, 1 = condenser probe, 2 = temperature showing probe) ⁽⁷⁾

LABEL	MIN.	MAX.	U.M.	DEF.	REGULATOR
r0	1	15	°C/°F ⁽⁶⁾	2	hysteresis (differential, it is relative to the working setpoint)
r1	-55	r2	°C/°F ⁽⁶⁾	-50	minimum value you can assign to the working setpoint
r2	r1	99	°C/°F ⁽⁶⁾	50	maximum value you can assign to the working setpoint